

REVISIONS:			
REV:	DESCRIPTION:	BY:	DATE:
A	description	by	xx/xx/xx

EXTERIOR SHEATHING
BY OTHERS

AV BARRIER BY OTHERS

NORTWOOD PANEL

PAN HEAD SCREW

WOOD STRAPPING IF REQUIRED

STARTER CLIP

FLASHING

CAULKING W/BACKER ROD
BY OTHERS

WINDOW HEAD

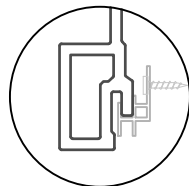

Tip: For small areas, flipped clips
can consider as a Starter

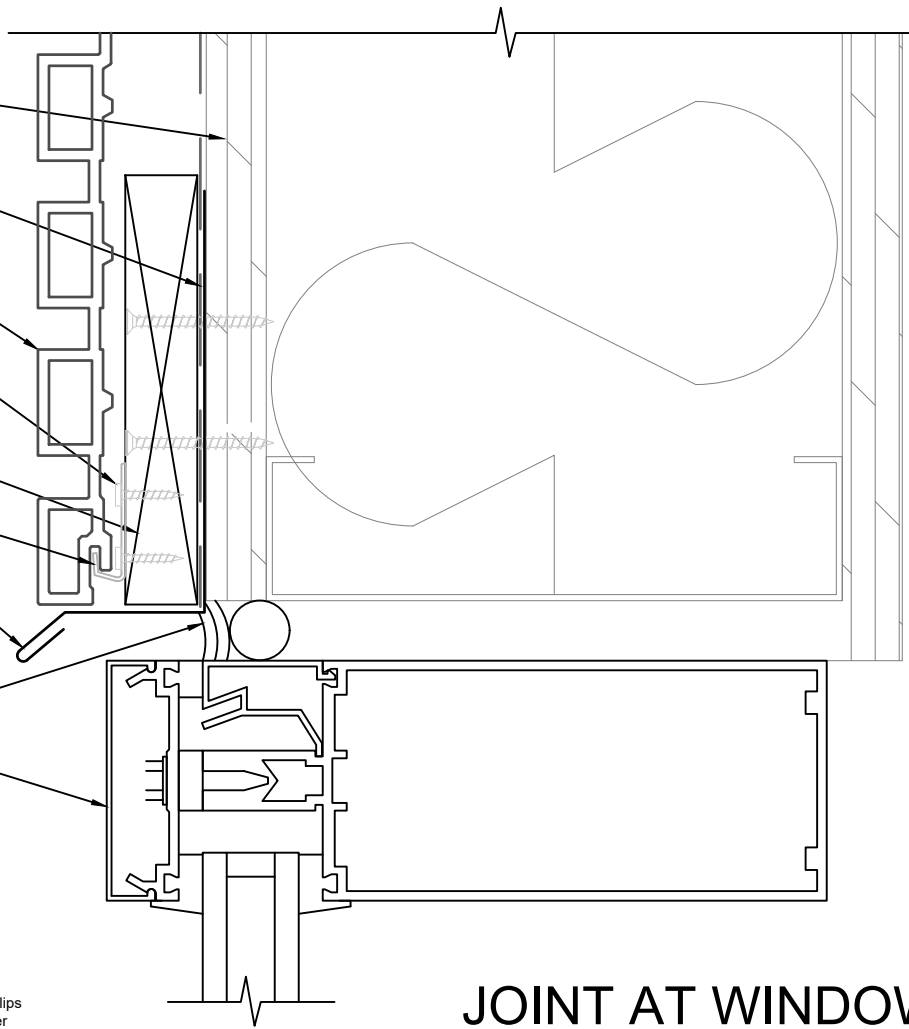

JOINT AT WINDOW HEAD

SITE: XXX	XX DRAWING NO.		XX PROJECT NO.	MM,DD,YY DATE.	 178 Pennsylvania Ave, Concord, ON L4K 4B1 Phone: 1(888)308-8898 email: info@nortwood.com www.nortwood.com
	TITLE: JOINT DETAIL @ WINDOW HEAD		1:2 SCALE AT A4.	AD DRAWN.	

REVISIONS:			
REV:	DESCRIPTION:	BY:	DATE:
A	description	by	xx/xx/xx

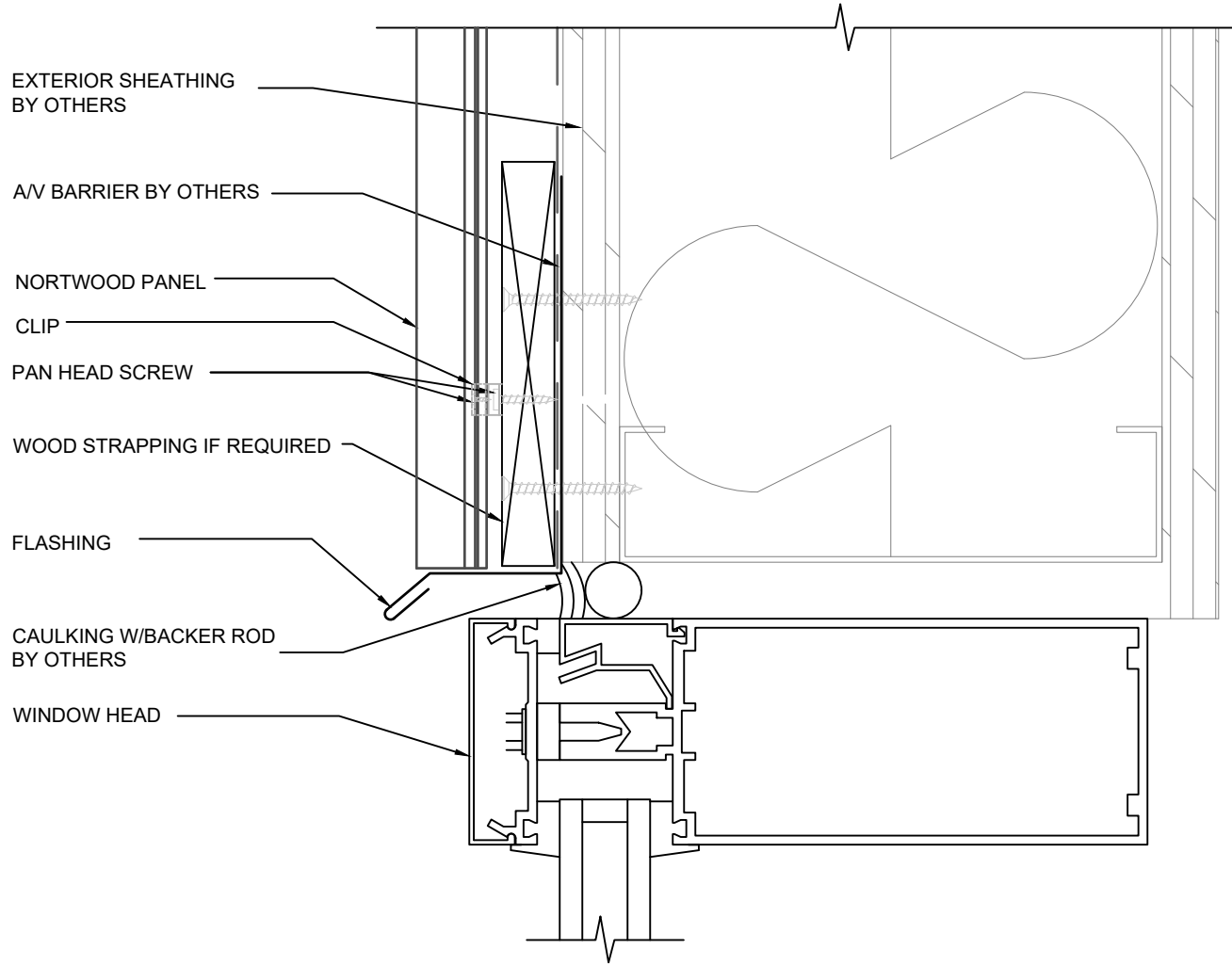

JOINT AT WINDOW HEAD

SITE: XXX	XX DRAWING NO.		XX PROJECT NO.	MM,DD,YY DATE.	 <p>178 Pennsylvania Ave, Concord, ON L4K 4B1 Phone: 1(888)308-8898 email: info@nortwood.com www.nortwood.com</p>
	TITLE: JOINT DETAIL @ WINDOW HEAD		1:2 SCALE AT A4.	AD DRAWN.	

REVISIONS:			
REV:	DESCRIPTION:	BY:	DATE:
A	description	by	xx/xx/xx

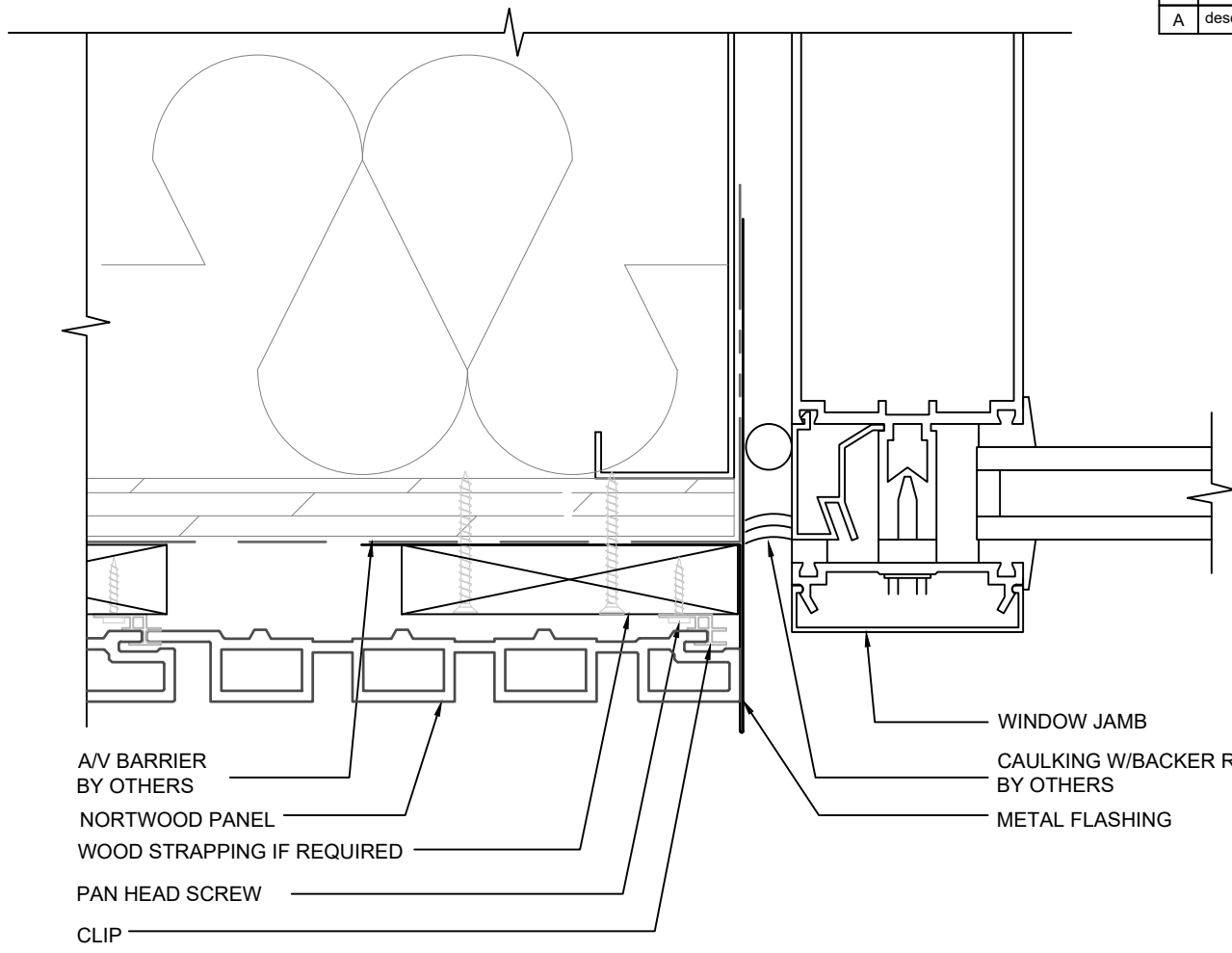

JOINT AT WINDOW JAMB (opt 1)

SITE: <div style="font-size: 24px; font-weight: bold; text-align: center;">XXX</div>	XX <small>DRAWING NO.</small>	XX <small>PROJECT NO.</small>	MM,DD,YY <small>DATE.</small>	<div style="border: 1px solid black; padding: 5px; font-weight: bold; font-size: 24px; color: #0070C0;">NORTwood</div>
TITLE: <div style="font-size: 24px; font-weight: bold;">JOINT DETAIL @ WINDOW JAMB</div>	1:2 <small>SCALE AT A4.</small>	AD <small>DRAWN.</small>	XX <small>CHECKED.</small>	00 <small>REVISION.</small>

178 Pennsylvania Ave, Concord, ON L4K 4B1
 Phone: 1(888)308-8898 email: info@nortwood.com
www.nortwood.com

REVISIONS:			
REV:	DESCRIPTION:	BY:	DATE:
A	description	by	xx/xx/xx

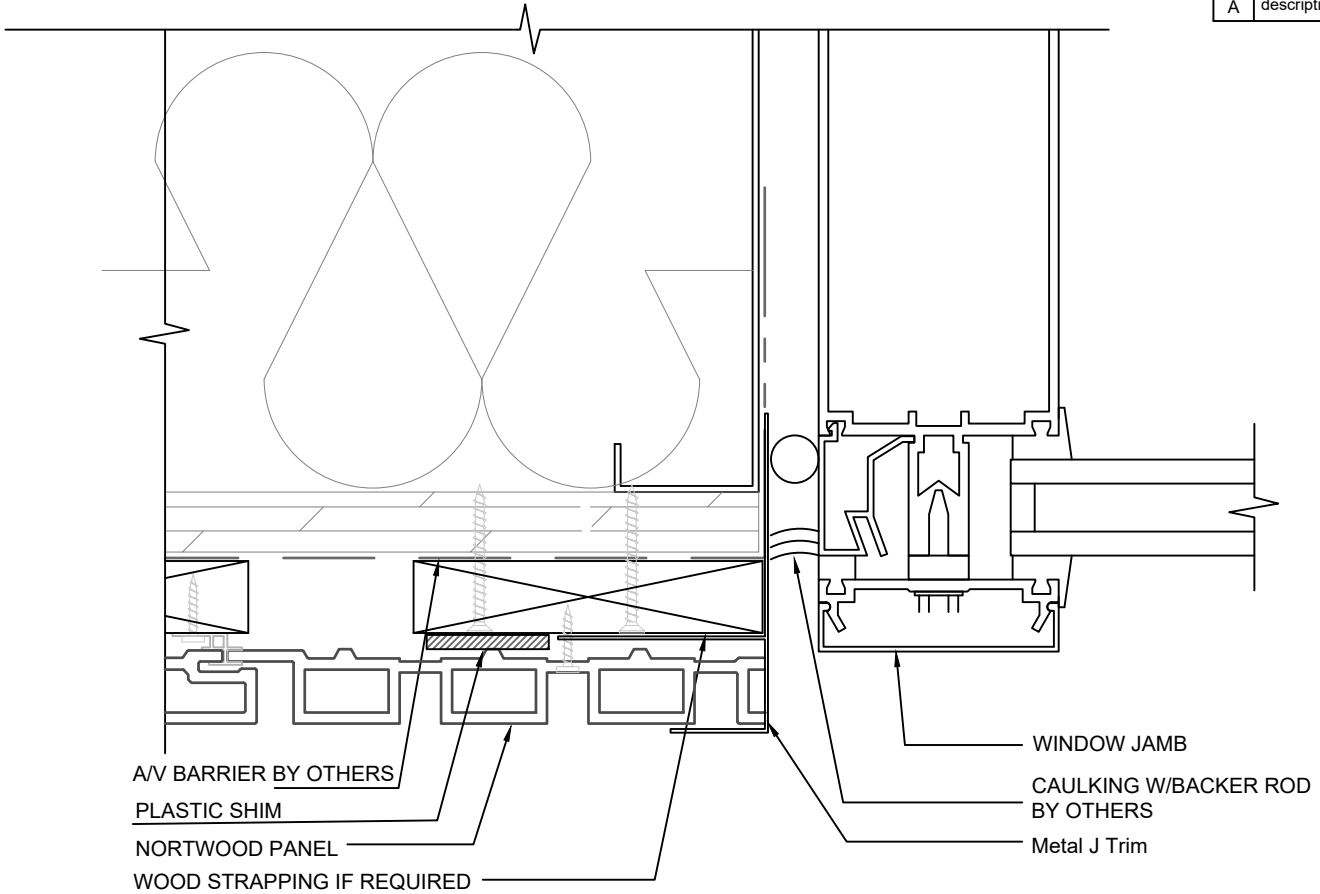

JOINT AT WINDOW JAMB (opt 2)

SITE: <div style="font-size: 24px; font-weight: bold; text-align: center;">XXX</div>	XX <small>DRAWING NO.</small>	XX <small>PROJECT NO.</small>	MM,DD,YY <small>DATE.</small>	<div style="border: 1px solid black; padding: 5px; font-weight: bold; font-size: 24px; margin-bottom: 10px;">NORTwood</div> <p style="font-size: 10px; margin: 0;">178 Pennsylvania Ave, Concord, ON L4K 4B1 Phone: 1(888)308-8898 email: info@nortwood.com www.nortwood.com</p>
TITLE: <div style="font-size: 18px; font-weight: bold;">JOINT DETAIL @ WINDOW JAMB</div>	1:2 <small>SCALE AT A4.</small>	AD <small>DRAWN.</small>	XX <small>CHECKED.</small>	

REVISIONS:			
REV:	DESCRIPTION:	BY:	DATE:
A	description	by	xx/xx/xx

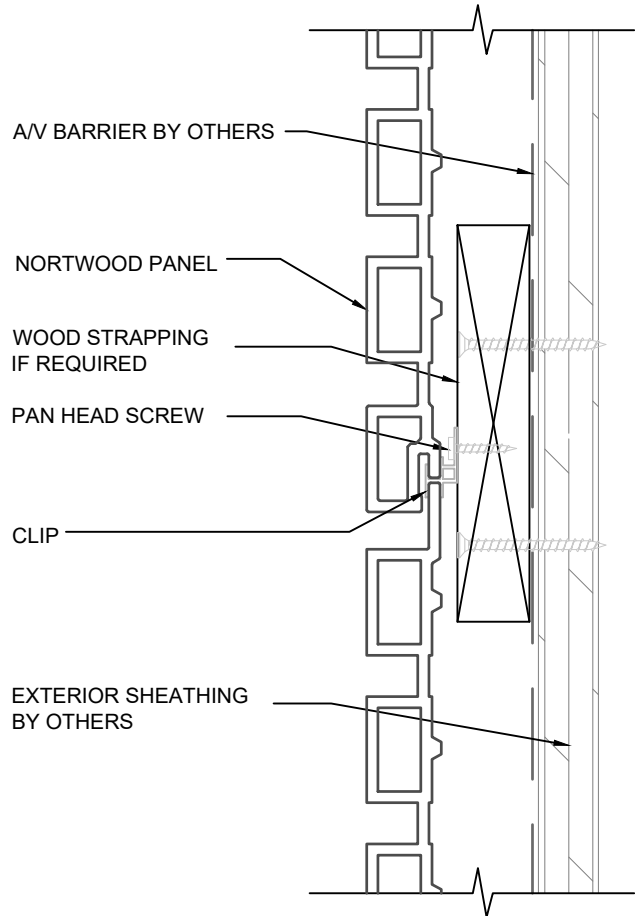

HORIZONTAL JOINT TYP.

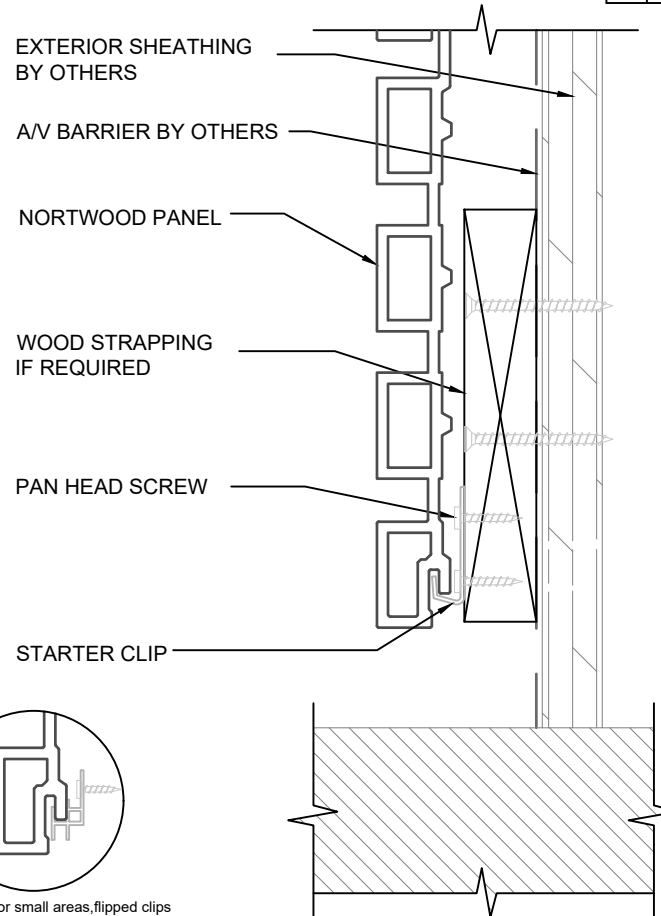

HORIZONTAL INS. END

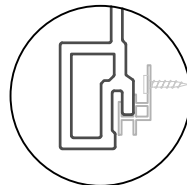

Tip: For small areas, flipped clips can consider as a Starter

SITE: XXX	XX DRAWING NO.		XX PROJECT NO.	MM,DD,YY DATE.	 <p>178 Pennsylvania Ave, Concord, ON L4K 4B1 Phone: 1(888)308-8898 email: info@nortwood.com www.nortwood.com</p>
	TITLE: JOINTS HORIZONTAL	1:2 SCALE AT A4.	AD DRAWN.	XX CHECKED.	

REVISIONS:			
REV:	DESCRIPTION:	BY:	DATE:
A	description	by	xx/xx/xx

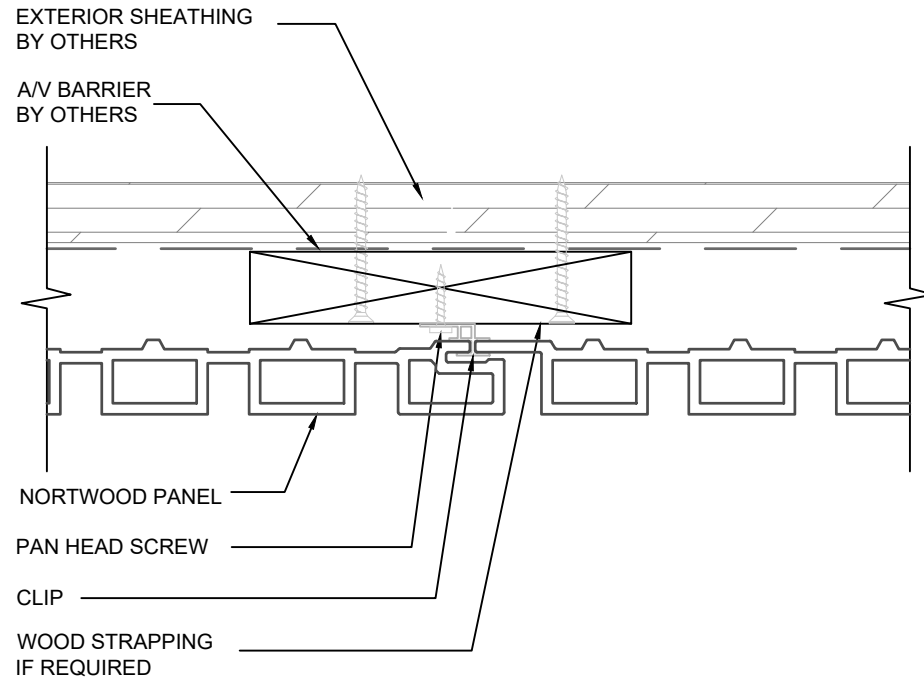

VERTICAL JOINT TYP.

SITE: XXX	XX DRAWING NO.		XX PROJECT NO.	MM,DD,YY DATE.	 178 Pennsylvania Ave, Concord, ON L4K 4B1 Phone: 1(888)308-8898 email: info@nortwood.com www.nortwood.com
	TITLE: JOINT VERTICAL	1:2 SCALE AT A4.	AD DRAWN.	XX CHECKED.	

REVISIONS:			
REV:	DESCRIPTION:	BY:	DATE:
A	description	by	xx/xx/xx

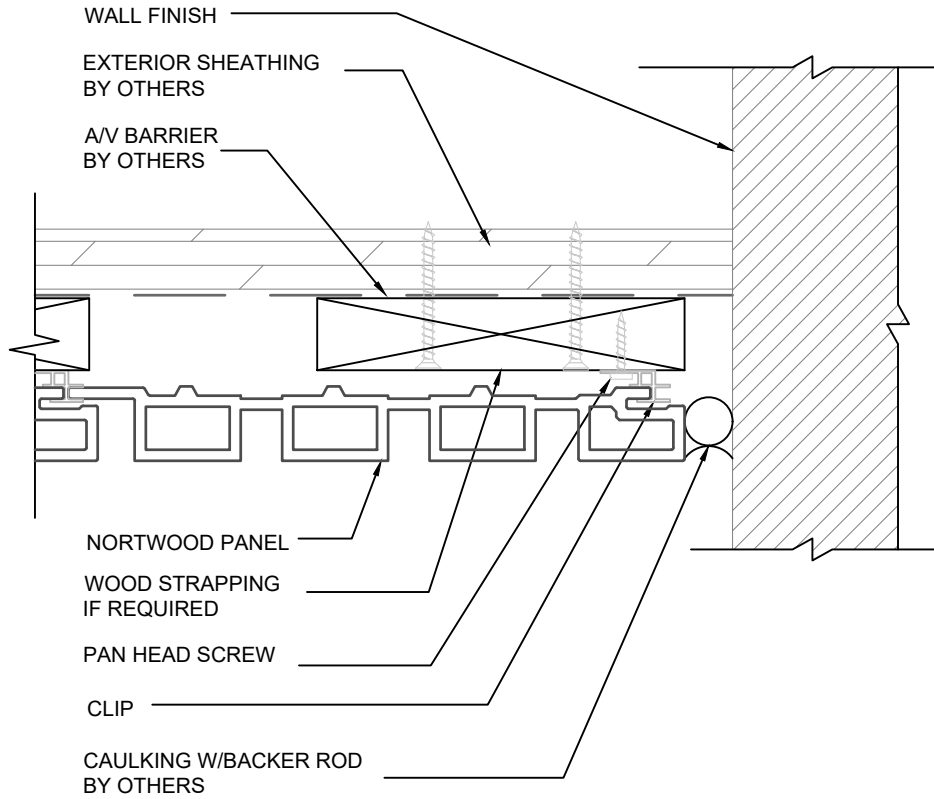

VERTICAL JOINT AT WALL TYP.

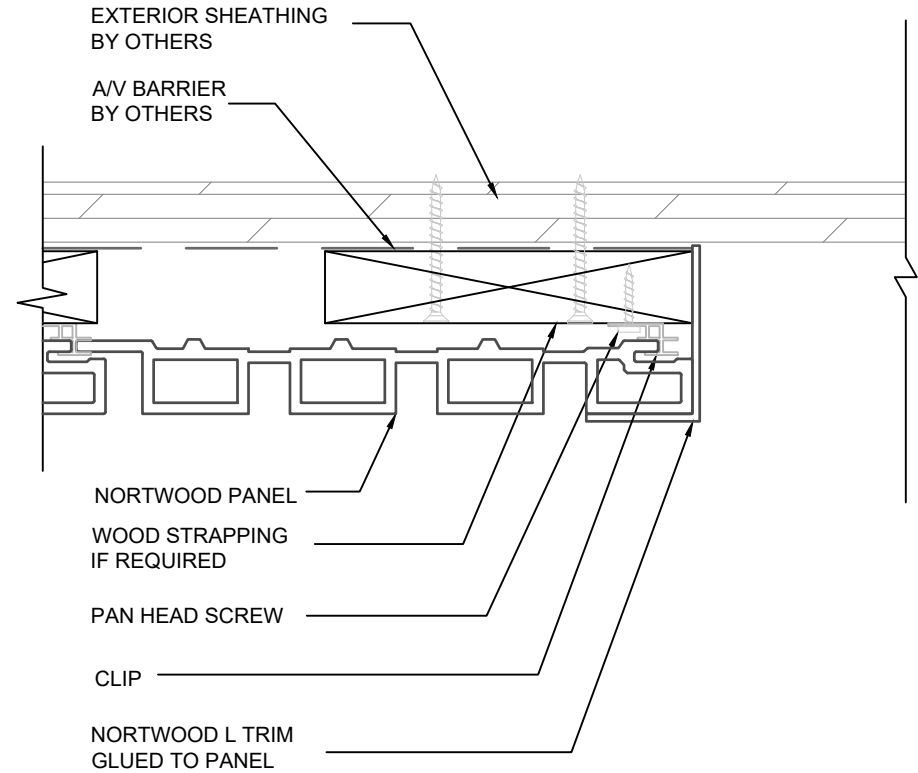

VERTICAL START INST. TYP.

SITE: XXX	XX DRAWING NO.		XX PROJECT NO.	MM,DD,YY DATE.	 <p>178 Pennsylvania Ave, Concord, ON L4K 4B1 Phone: 1(888)308-8898 email: info@nortwood.com www.nortwood.com</p>
	TITLE: JOINT STARTER	1:2 SCALE AT A4.	AD DRAWN.	XX CHECKED.	

REVISIONS:			
REV:	DESCRIPTION:	BY:	DATE:
A	description	by	xx/xx/xx

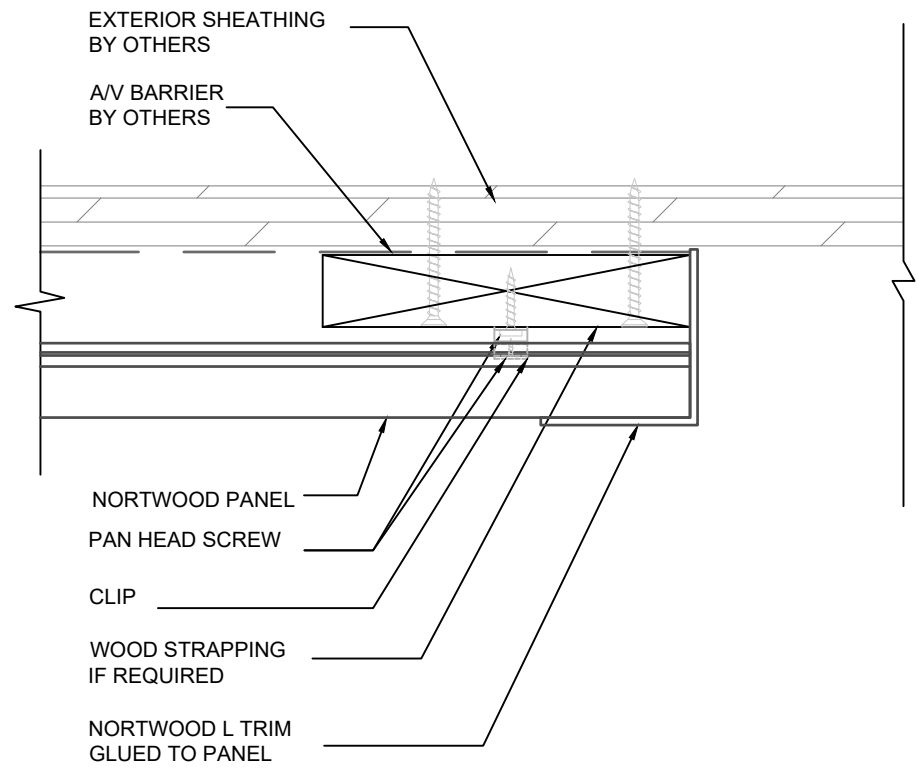
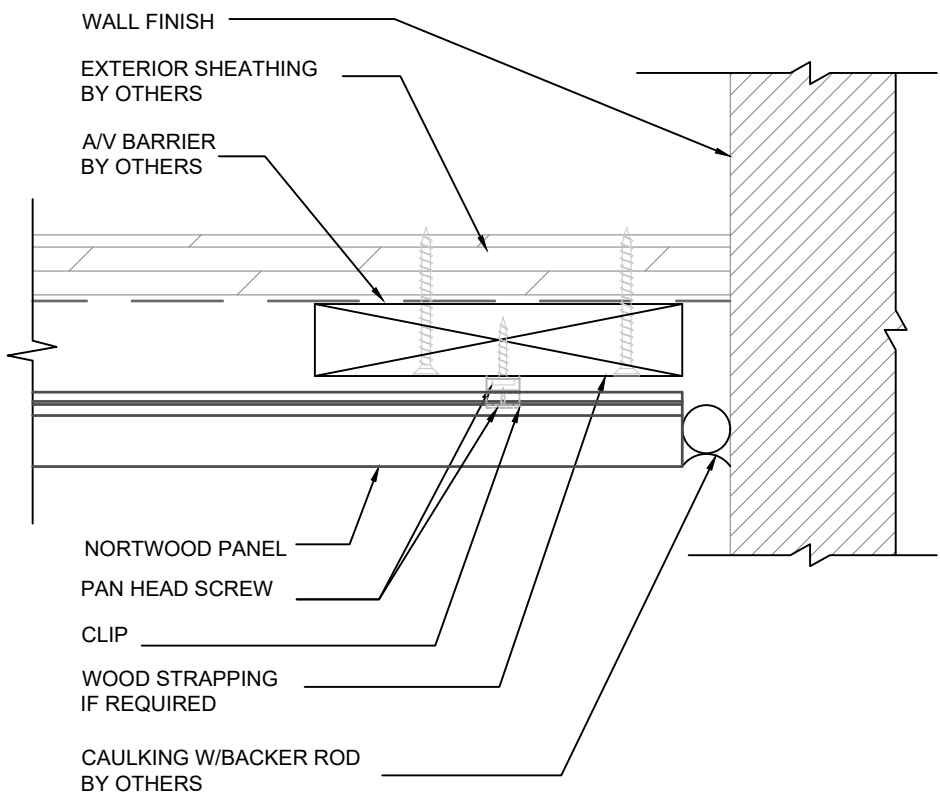

HORIZONTAL JOINT AT WALL TYP.

HORIZONTAL START INST. TYP.

SITE: XXX	DRAWING NO. XX	PROJECT NO. XX	DATE. MM,DD,YY	 178 Pennsylvania Ave, Concord, ON L4K 4B1 Phone: 1(888)308-8898 email: info@nortwood.com www.nortwood.com
TITLE: JOINT AT BOTTOM OF WALL	SCALE AT A4. 1:2	DRAWN. AD	REVISION. XX 00	

REVISIONS:			
REV:	DESCRIPTION:	BY:	DATE:
A	description	by	xx/xx/xx

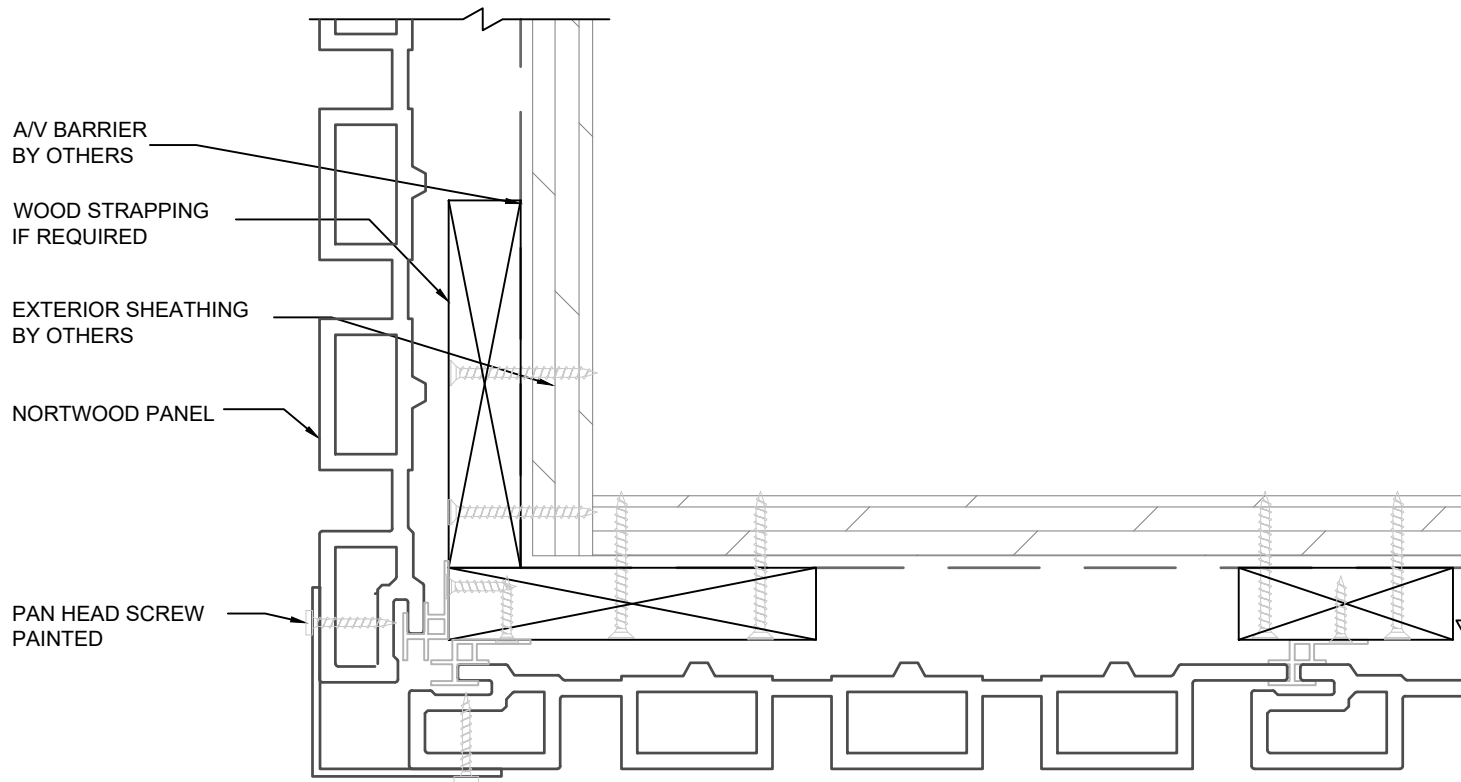

CORNER L TRIM JOINT (opt 1)

SITE: <div style="font-size: 24px; font-weight: bold; text-align: center;">XXX</div>	XX <small>DRAWING NO.</small>	XX <small>PROJECT NO.</small>	MM,DD,YY <small>DATE.</small>	<div style="font-size: 24px; font-weight: bold; border: 1px solid black; padding: 5px; display: inline-block;">NORTwood</div> <small>178 Pennsylvania Ave, Concord, ON L4K 4B1 Phone: 1(888)308-8898 email: info@nortwood.com www.nortwood.com</small>
TITLE: <div style="font-size: 18px; font-weight: bold;">JOINT @ CORNER WITH L TRIM</div>	<div style="font-size: 18px; font-weight: bold;">1:2</div> <small>SCALE AT A4.</small>	<div style="font-size: 18px; font-weight: bold;">AD</div> <small>DRAWN.</small>	<div style="font-size: 18px; font-weight: bold;">XX</div> <small>CHECKED.</small>	

REVISIONS:			
REV:	DESCRIPTION:	BY:	DATE:
A	description	by	xx/xx/xx

A/V BARRIER
BY OTHERS

EXTERIOR SHEATHING
BY OTHERS

NORTWOOD PANEL

1/4 " SCREW

CORNER L TRIM (opt 2)

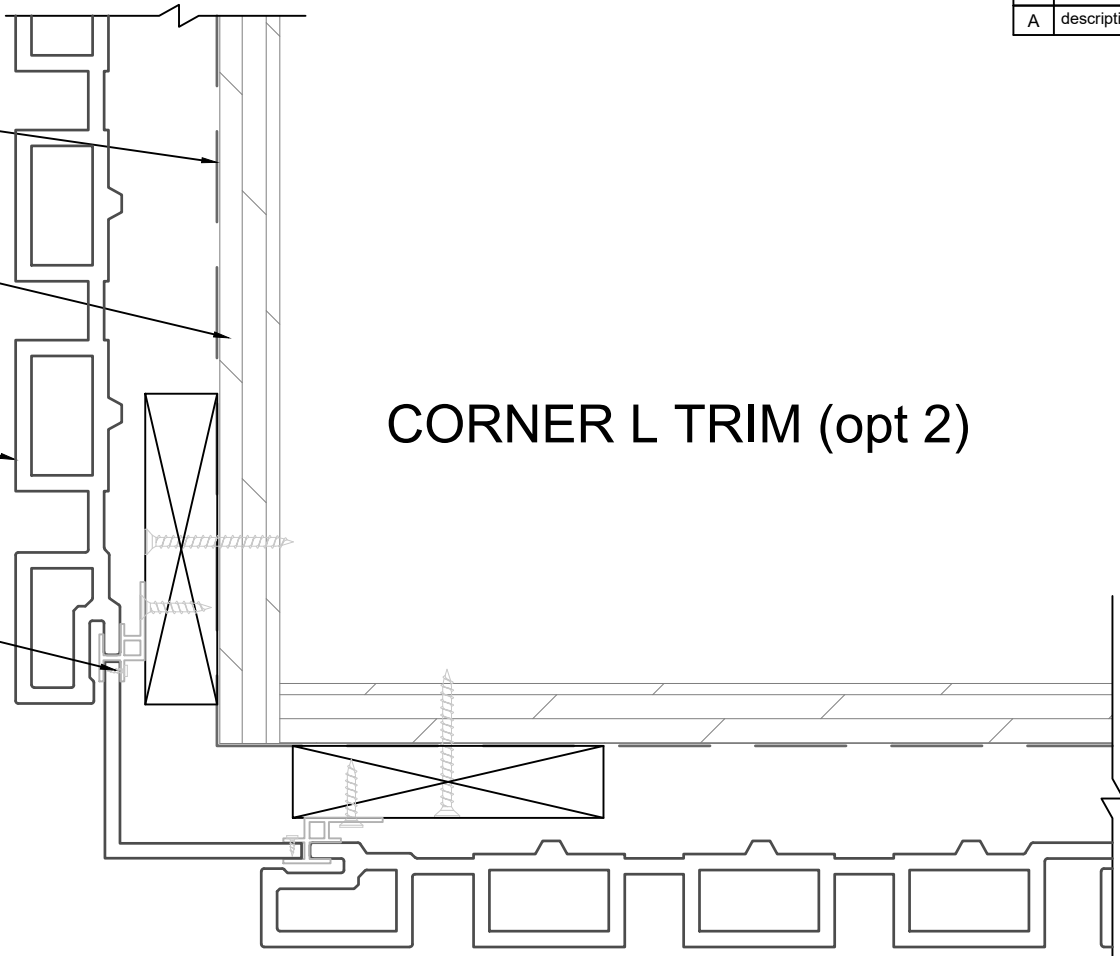

SITE: XXX	XX DRAWING NO.		XX PROJECT NO.	MM,DD,YY DATE.	 178 Pennsylvania Ave, Concord, ON L4K 4B1 Phone: 1(888)308-8898 email: info@nortwood.com www.nortwood.com
	TITLE: JOINT @ CORNER WITH L TRIM	1:2 SCALE AT A4.	AD DRAWN.	XX CHECKED.	

REVISIONS:			
REV:	DESCRIPTION:	BY:	DATE:
A	description	by	xx/xx/xx

AV BARRIER
BY OTHERS

WOOD STRAPPING
IF REQUIRED

EXTERIOR SHEATHING
BY OTHERS

NORTWOOD PANEL

PAN HEAD SCREW
PAINTED

SHIM

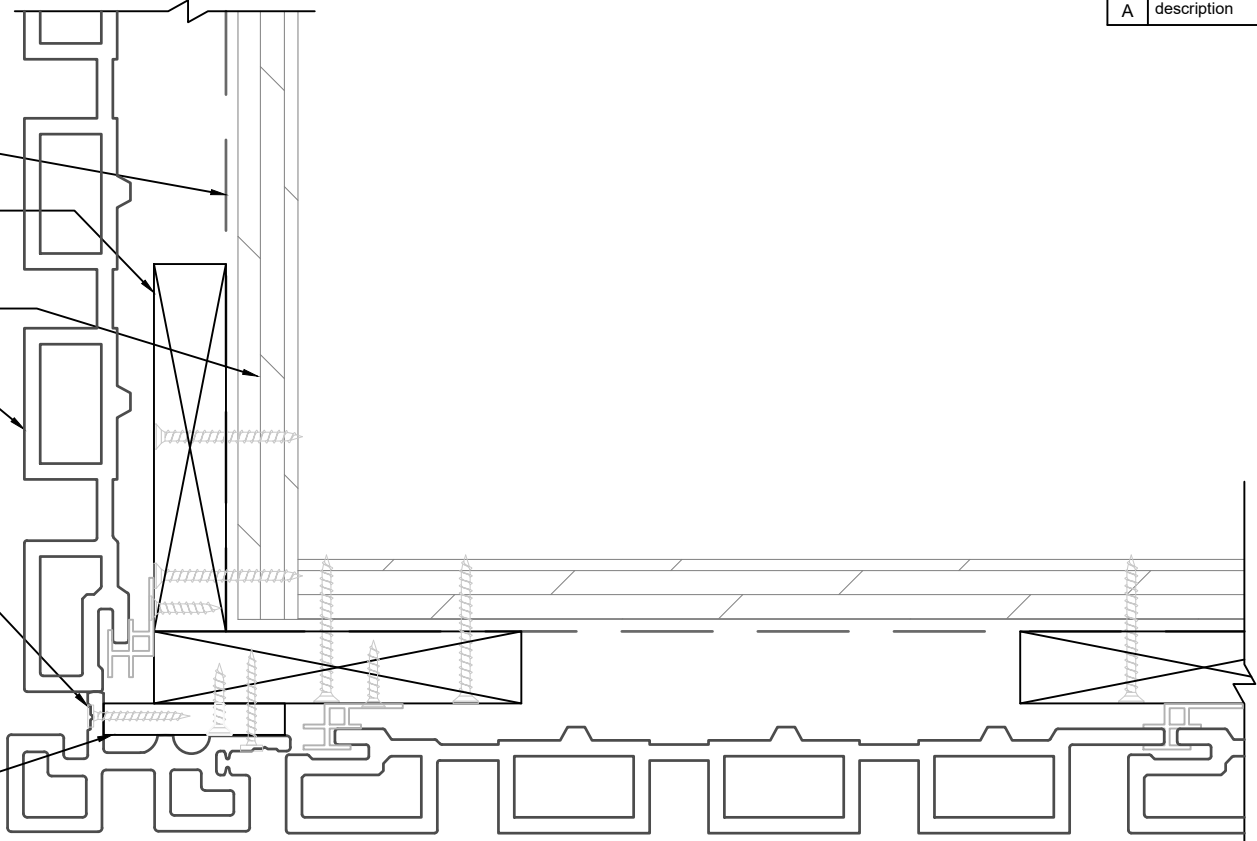

CORNER JOINT

SITE: XXX	XX DRAWING NO.	XX PROJECT NO.	MM,DD,YY DATE.	 178 Pennsylvania Ave, Concord, ON L4K 4B1 Phone: 1(888)308-8898 email: info@nortwood.com www.nortwood.com
TITLE: JOINT @ CORNER BUTT JOINTED	1:2 SCALE AT A4.	AD DRAWN.	XX CHECKED.	

REVISIONS:			
REV:	DESCRIPTION:	BY:	DATE:
A	description	by	xx/xx/xx

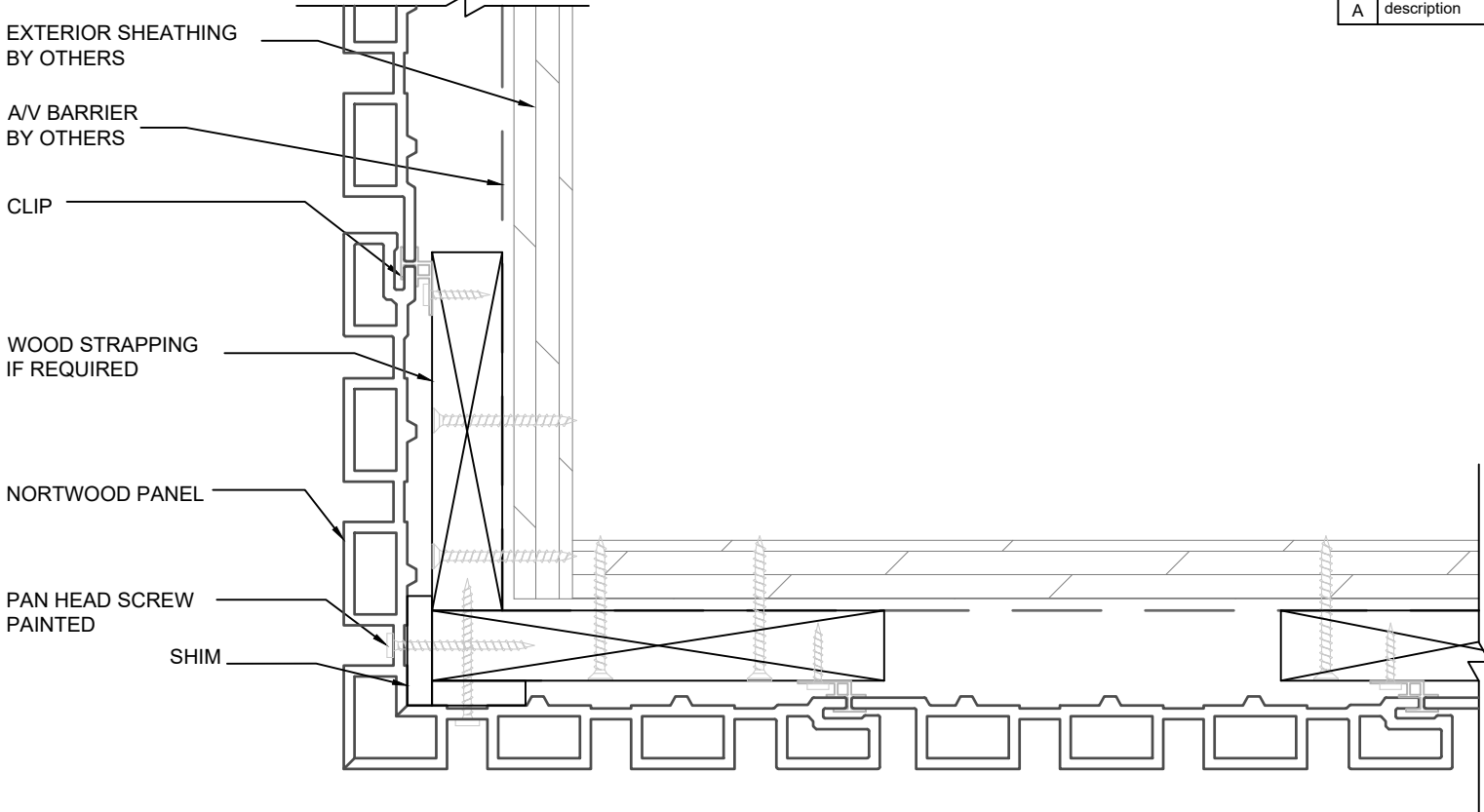

CORNER MITERED

SITE: XXX	XX DRAWING NO.		XX PROJECT NO.	MM,DD,YY DATE.	 <p>178 Pennsylvania Ave, Concord, ON L4K 4B1 Phone: 1(888)308-8898 email: info@nortwood.com www.nortwood.com</p>
	TITLE: JOINT @ CORNER MITERED	1:2 SCALE AT A4.	AD DRAWN.	XX CHECKED.	

REVISIONS:			
REV:	DESCRIPTION:	BY:	DATE:
A	description	by	xx/xx/xx

A/V BARRIER
BY OTHERS

NORTWOOD PANEL

EXTERIOR SHEATHING
BY OTHERS

WOOD STRAPPING
IF REQUIRED

PAN HEAD SCREW

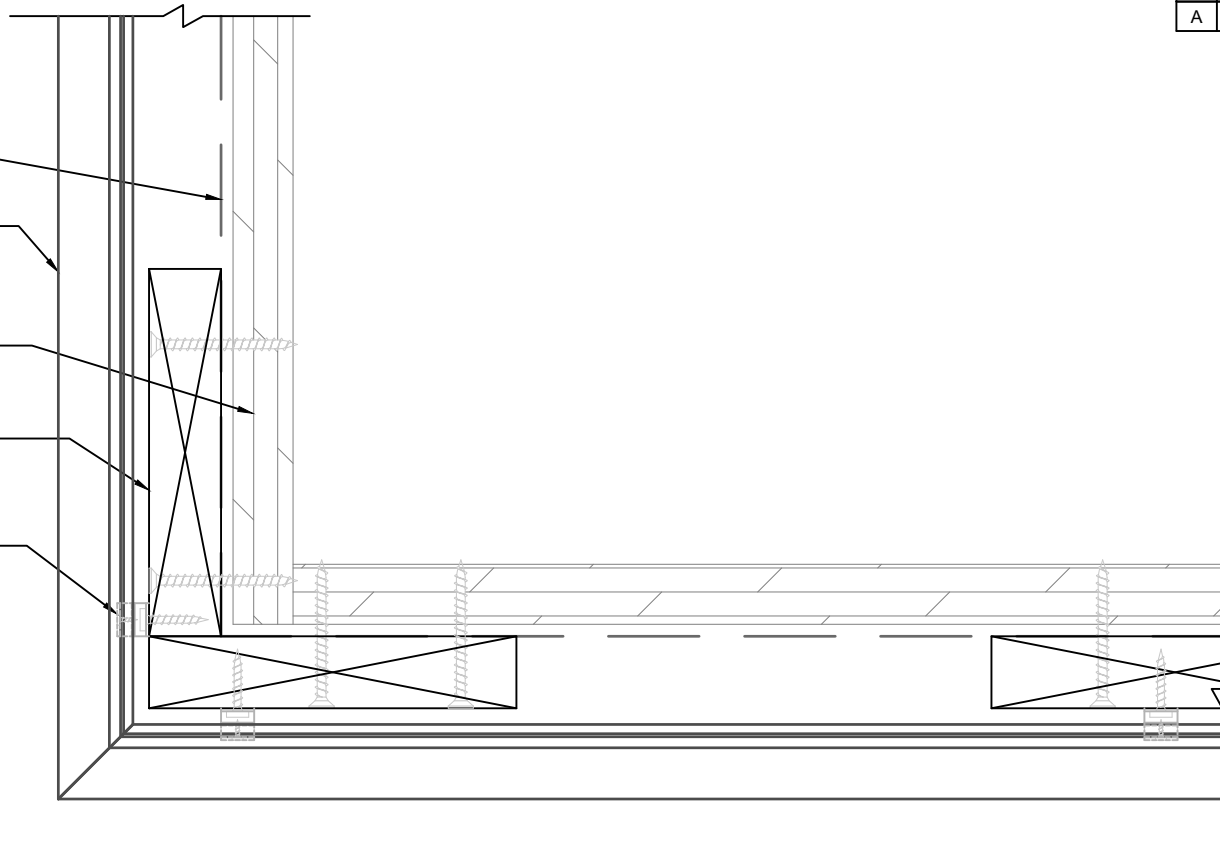

CORNER HORIZONTAL MITERED

SITE: XXX	XX DRAWING NO.	XX PROJECT NO.	MM,DD,YY DATE.	 178 Pennsylvania Ave, Concord, ON L4K 4B1 Phone: 1(888)308-8898 email: info@nortwood.com www.nortwood.com
TITLE: JOINT @ CORNER MITERED	1:2 SCALE AT A4.	AD DRAWN.	XX CHECKED.	

REVISIONS:			
REV:	DESCRIPTION:	BY:	DATE:
A	description	by	xx/xx/xx

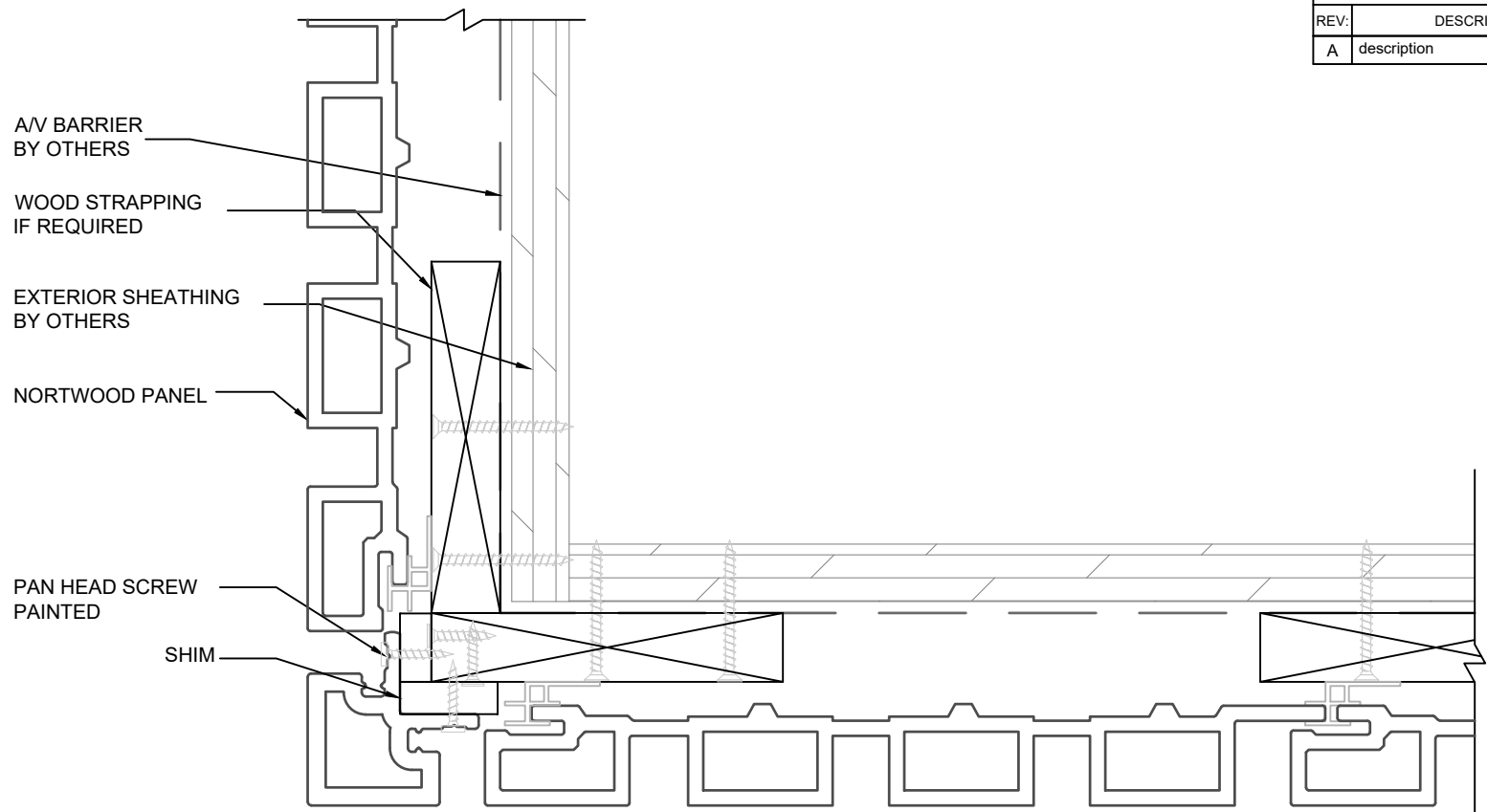

CORNER JOINT

SITE: XXX	XX DRAWING NO.	XX PROJECT NO.	MM,DD,YY DATE.	 <p>178 Pennsylvania Ave, Concord, ON L4K 4B1 Phone: 1(888)308-8898 email: info@nortwood.com www.nortwood.com</p>
TITLE: JOINT @ CORNER MITERED	1:2 SCALE AT A4.	AD DRAWN.	XX CHECKED.	

REVISIONS:			
REV:	DESCRIPTION:	BY:	DATE:
A	description	by	xx/xx/xx

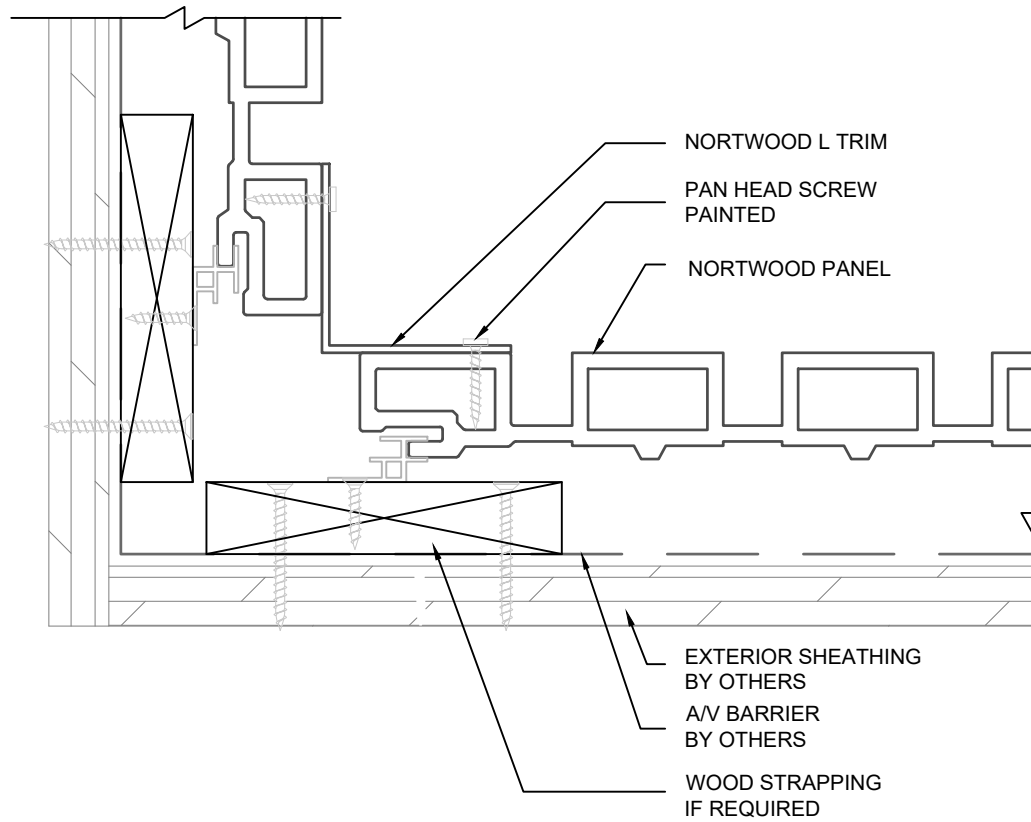

INSIDE CORNER L TRIM (OPTIONAL)

SITE: XXX	XX DRAWING NO.		XX PROJECT NO.	MM,DD,YY DATE.	 178 Pennsylvania Ave, Concord, ON L4K 4B1 Phone: 1(888)308-8898 email: info@nortwood.com www.nortwood.com
	TITLE: INSIDE CORNER WITH L TRIM	1:2 SCALE AT A4.	AD DRAWN.	XX CHECKED.	

REVISIONS:			
REV:	DESCRIPTION:	BY:	DATE:
A	description	by	xx/xx/xx

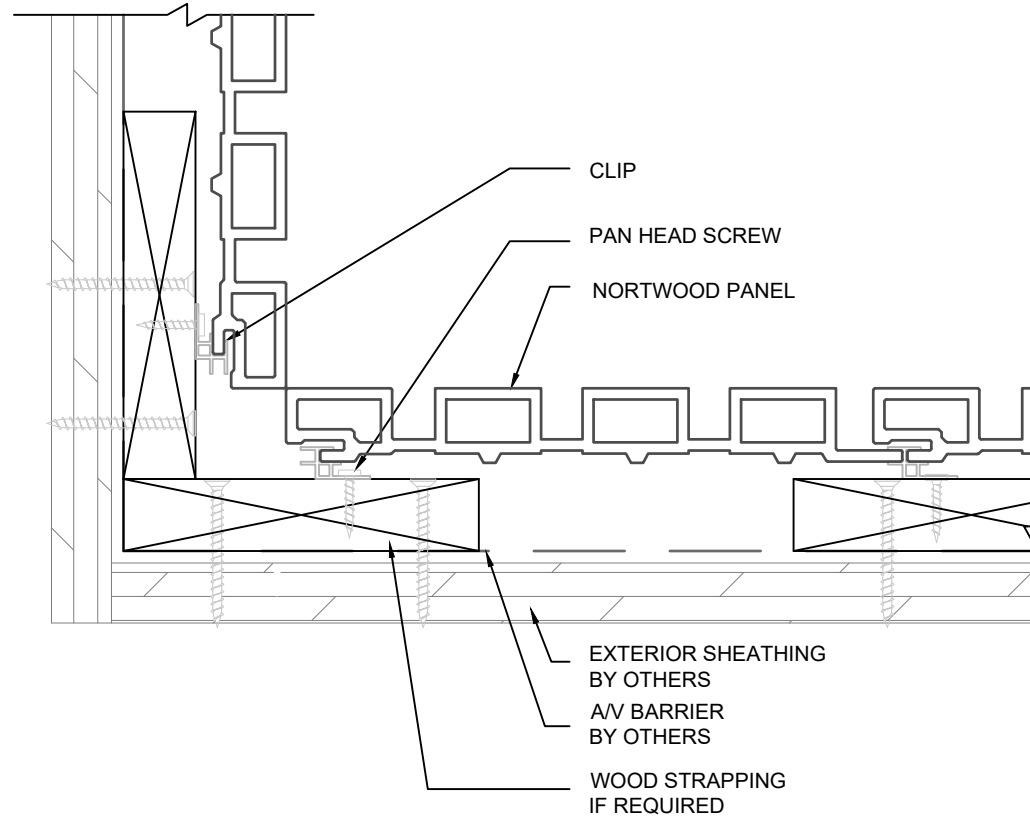

INSIDE CORNER BUTT JOINT

SITE: XXX	XX DRAWING NO.		XX PROJECT NO.	MM,DD,YY DATE.	 178 Pennsylvania Ave, Concord, ON L4K 4B1 Phone: 1(888)308-8898 email: info@nortwood.com www.nortwood.com
	TITLE: INSIDE CORNER BUTT JOINT	1:2 SCALE AT A4.	AD DRAWN.	XX CHECKED.	

REVISIONS:			
REV:	DESCRIPTION:	BY:	DATE:
A	description	by	xx/xx/xx

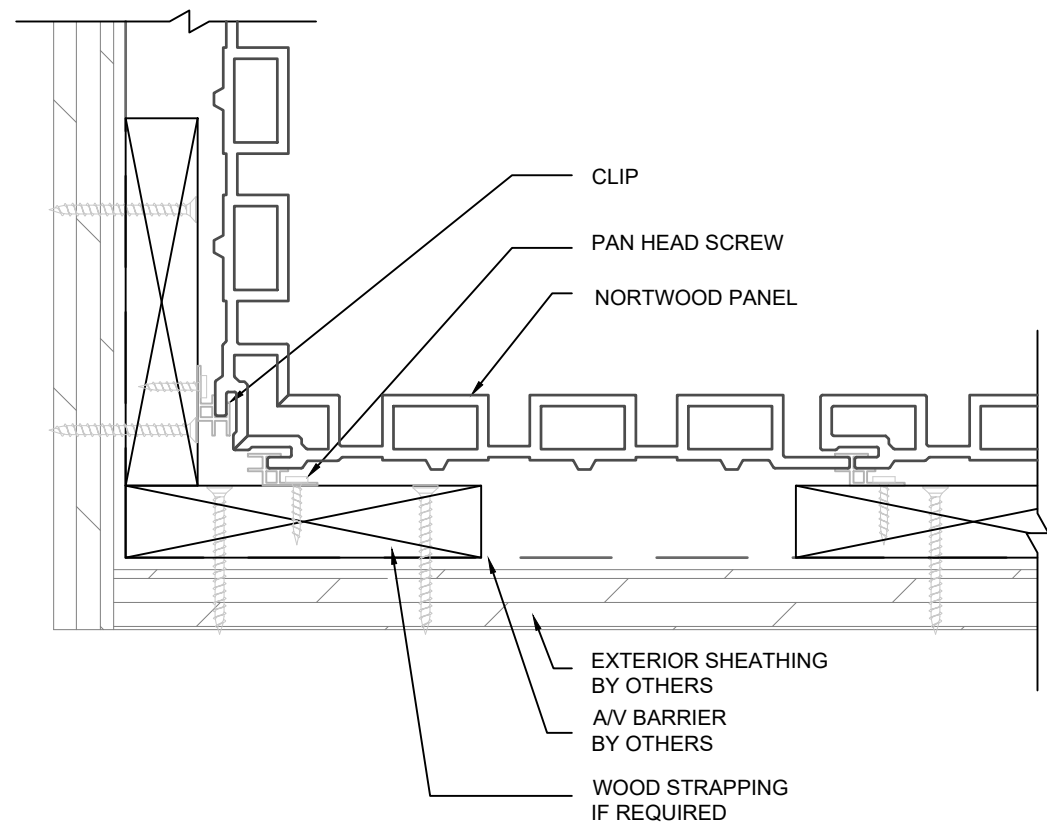

INSIDE CORNER MITERED

SITE: XXX	XX DRAWING NO.		XX PROJECT NO.	MM,DD,YY DATE.	 <p>178 Pennsylvania Ave, Concord, ON L4K 4B1 Phone: 1(888)308-8898 email: info@nortwood.com www.nortwood.com</p>
	TITLE: INSIDE CORNER MITERED	1:2 SCALE AT A4.	AD DRAWN.	XX CHECKED.	

REVISIONS:			
REV:	DESCRIPTION:	BY:	DATE:
A	description	by	xx/xx/xx

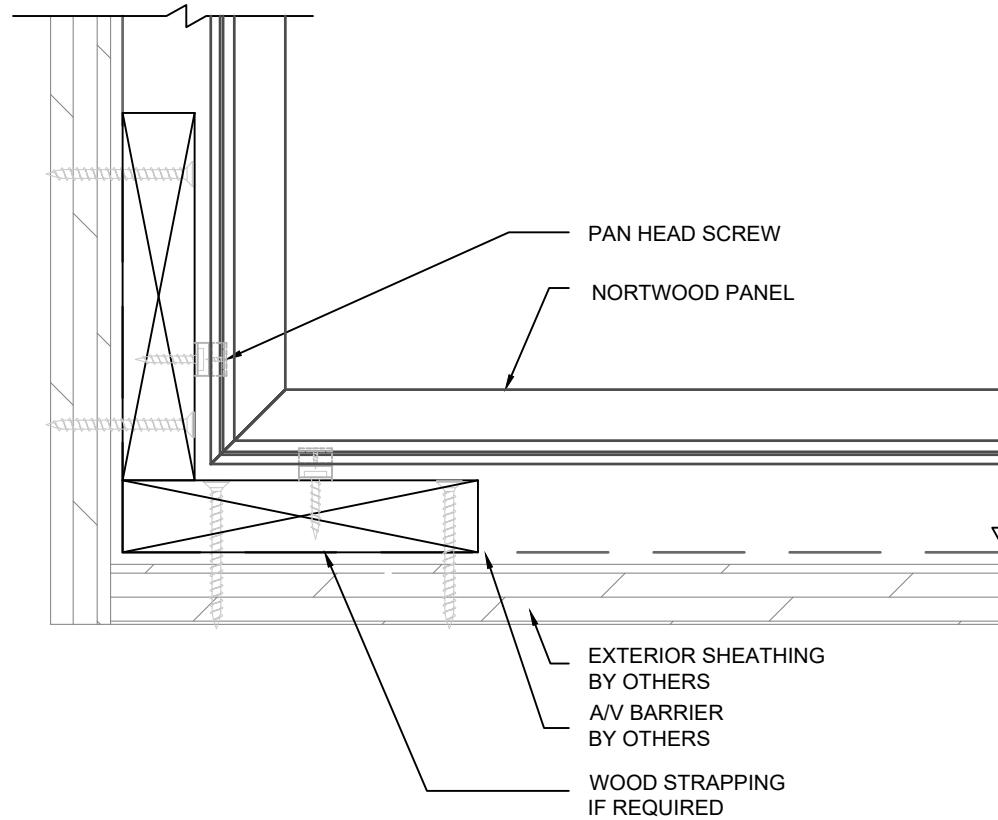

INSIDE HORIZONTAL CORNER MITERED

SITE: XXX	XX DRAWING NO.		XX PROJECT NO.	MM,DD,YY DATE.	 <p>178 Pennsylvania Ave, Concord, ON L4K 4B1 Phone: 1(888)308-8898 email: info@nortwood.com www.nortwood.com</p>
	TITLE: INSIDE CORNER MITERED	1:2 SCALE AT A4.	AD DRAWN.	XX CHECKED.	

REVISIONS:			
REV:	DESCRIPTION:	BY:	DATE:
A	description	by	xx/xx/xx

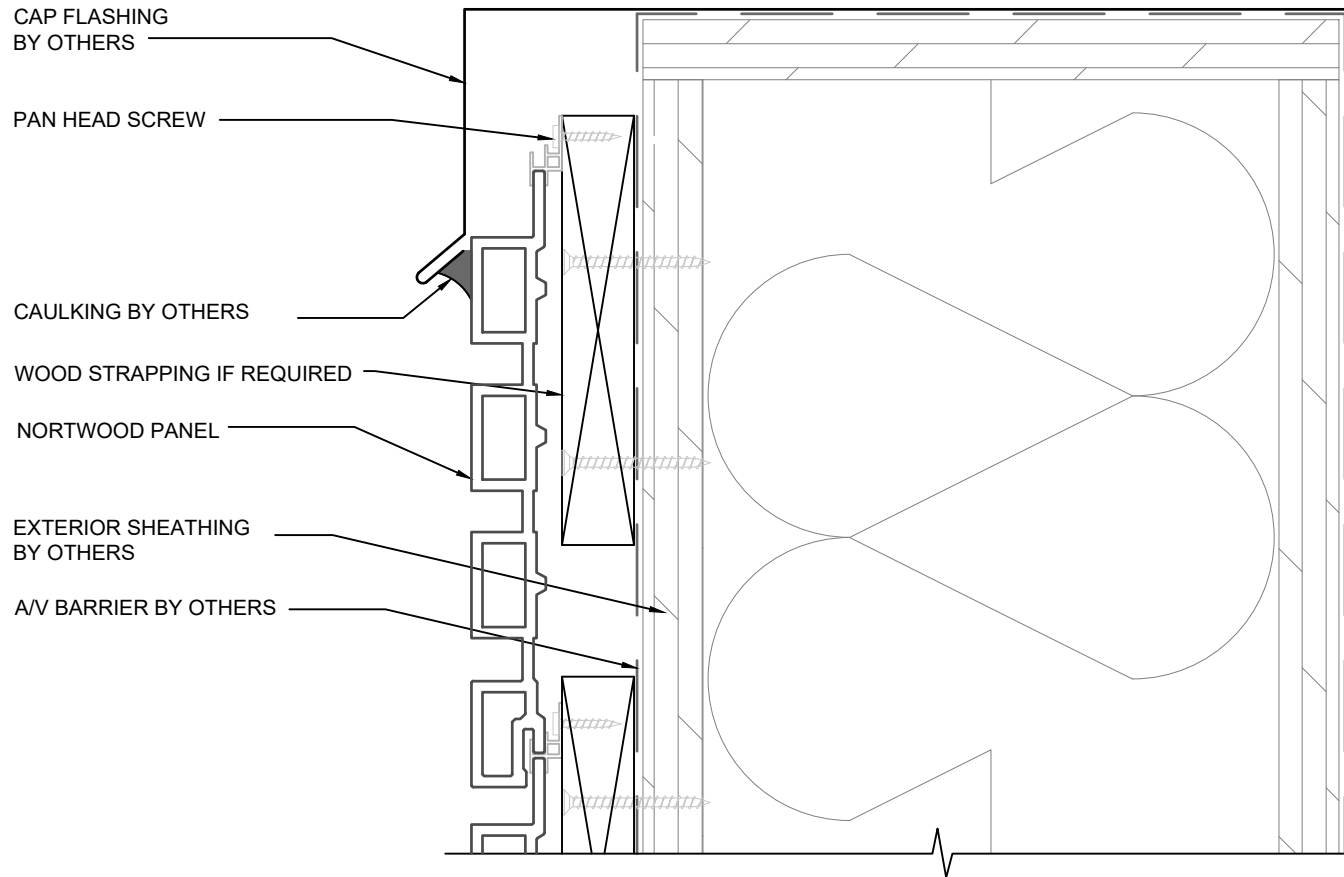

END AT PARAPET W/CAP FLASHING

SITE: XXX	XX DRAWING NO.	XX PROJECT NO.	MM,DD,YY DATE.	 <p>178 Pennsylvania Ave, Concord, ON L4K 4B1 Phone: 1(888)308-8898 email: info@nortwood.com www.nortwood.com</p>
TITLE: END @ PARAPET WITH CAP FLASHING	1:2 SCALE AT A4.	AD DRAWN.	XX CHECKED.	